

INDOOR

XVA

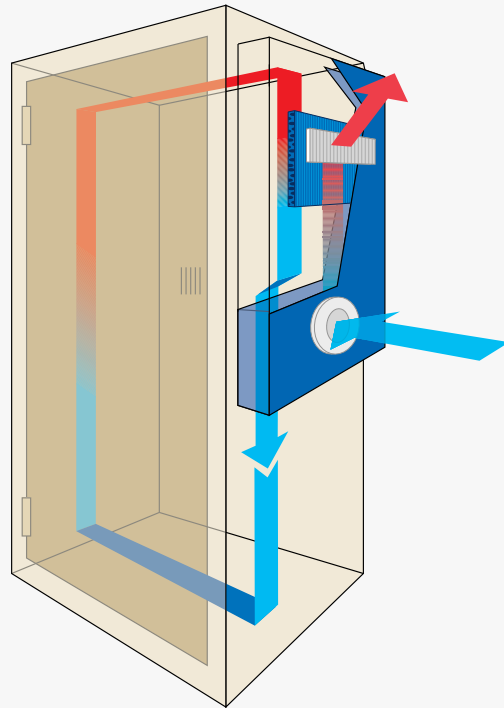

EN COMMON FEATURES

- Air/Air Heat Exchangers
- 4 sizes
- Patented heat exchange core made of aluminium, to ensure high efficiency with compact dimensions
- Specific Heat Transmission 16-85 W/K



HE

XVA XVA16

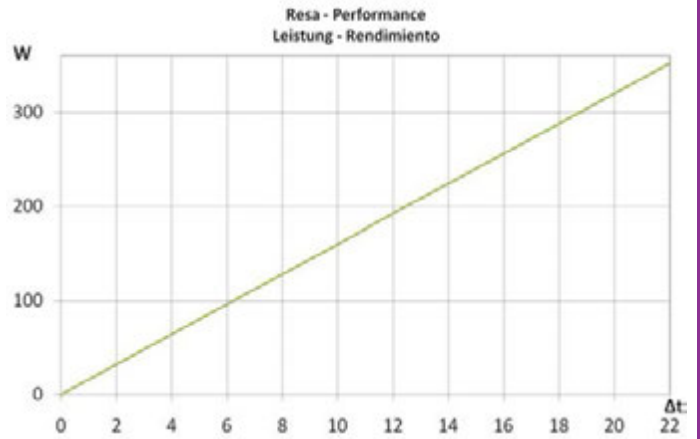
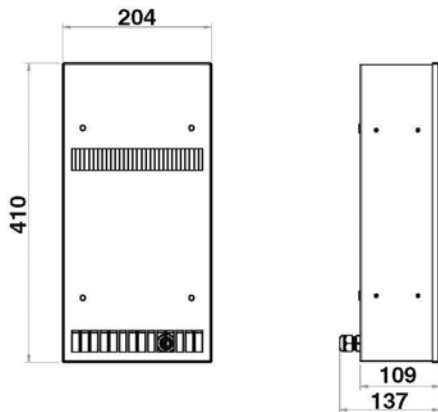

EXTERNAL INSTALLATION

INTERNAL INSTALLATION

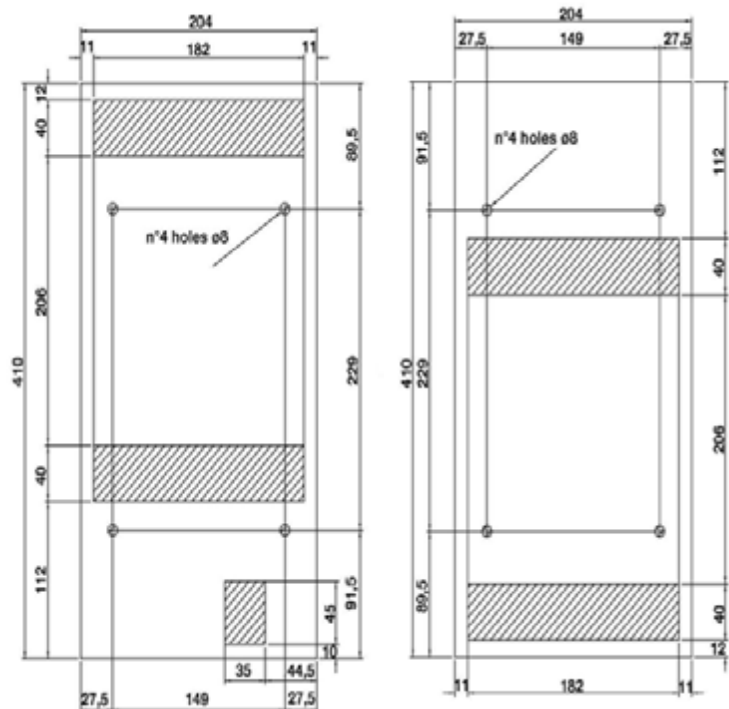

CODE - CODICE - MODEL - CODIGO	M.U.	XVA1600320	XVA16U1303
Power supply - Alimentazione - Spannungsversorgung - Tensiòn	V - ph - Hz	230-1-50/60	115-1-60
Specific heat transmission - Resa specifica - Spezifische Leistung - Rendimiento específico	W/K	16	16
Height / Widht / Depth - Altezza / Larghezza/Profondità Höhe / Breite / Tiefe - Altura / Ancho / Profundidad	mm	410x204x109	410x204x109
Absorbed current - Corrente assorbita - Stromaufnahme - Corriente absorbida	A	0,6	0,6
Pre-Fuse T - Fusibile T - Absicherung T - Elemento previo de fusibile T	A	2	2
Power consumption - Potenza assorbita - Leistungaufnahme - Potencia absorbida	W	64	40
Side cabinet fan flow, free blowing - Portata aria ventil. lato armadio, bocca libera Luftmenge Schrankseite, freiblasend - Caudal aire ventil. Lado armario	m ³ /h	100	100
Regulation Temperature limits - Limiti di regolazione Temperatura Temperatur Einstellbereich - limites de ajuste de Temperatura	°C	-5 / +55	-5 / +55
Side ambient Temperature limits - Limiti di Temperatura lato ambiente Umgebungstemperatur - Limites Temperatura lado ambiente	°C	-5 / +55	-5 / +55
Side cabinet protection degree - Protezione lato armadio Schutzgrad Schrankseite - Protección lado armario	IP/Type	54	54/12
Noise level - Rumorosità - Geräuschpegel - Nivel de ruido	dB(A)	58	58
Weight - Peso - Gewicht - Peso	kg	4,6	4,6
Installation - Installazione - Installation - Instalación		Internal / External	Internal / External
Mechanical Thermostat - Termostato Meccanico - Mechanischer Thermostat - Termostato mecánico		No	No

OPTIONAL

Special Colour - Colore Speciale OCAXNS06
Stainless Steel Housing - Carpentaria Inox AISI304 OCAXI01



Indoor Heat Exchanger

HE

**XVA
XVA35**

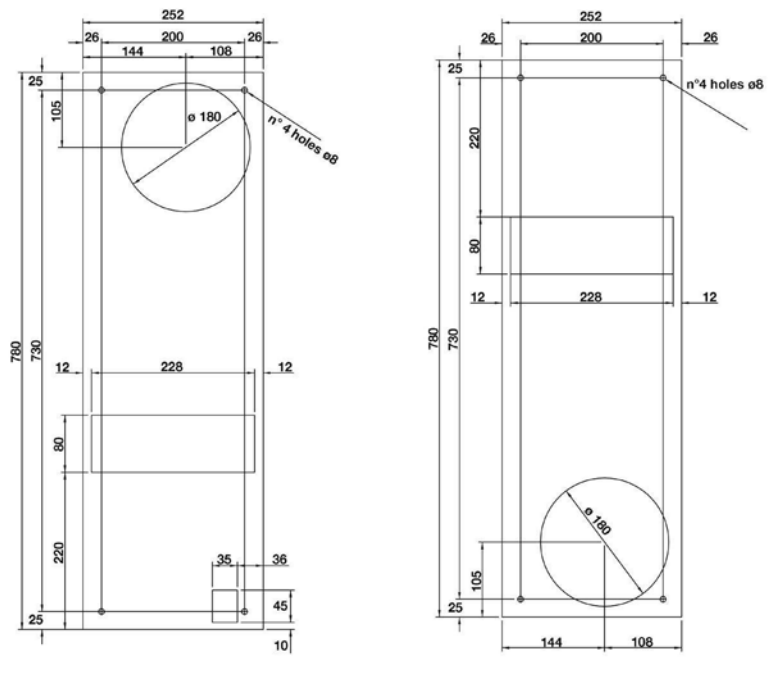
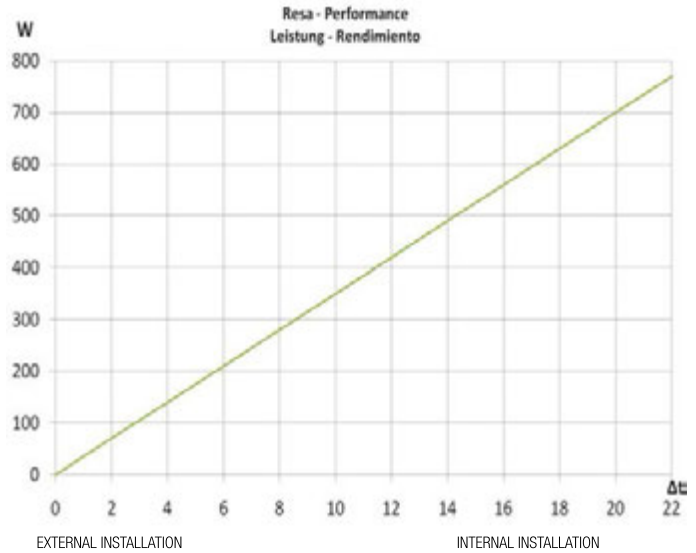
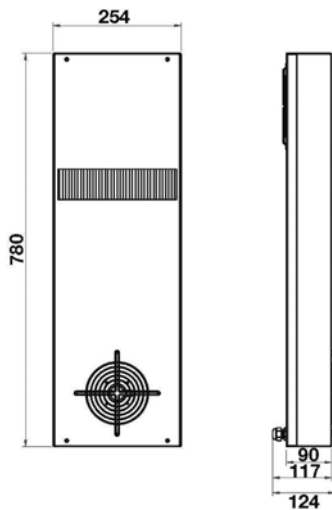

CODE - CODICE - MODEL - CODIGO	M.U.	XVA3500320	XVA35T0120	XVA35T0220	XVA35U1320	XVA35U1303
Power supply - Alimentazione - Spannungsversorgung - Tensión	V - ph - Hz	230-1-50/60	230-1-50/60	230-1-50/60	230-1-60	115-1-60
Specific heat transmission - Resa specifica Spezifische Leistung - Rendimiento específico	W/K	35	35	35	35	35
Height / Widht / Depth - Altezza / Larghezza/Profondità Höhe / Breite / Tiefe - Altura / Ancho / Profundidad	mm	780x254x90	780x254x90	780x254x90	780x254x90	780x254x90
Absorbed current - Corrente assorbita Stromaufnahme - Corriente absorbida	A	0,72	0,72	0,72	0,8	1,1
Pre-Fuse T - Fusibile T - Absicherung T Elemento previo de fusibile T	A	2	2	2	2	4
Power consumption - Potenza assorbita Leistungsaufnahme - Potencia absorbida	W	160	160	160	150	180
Side cabinet fan flow, free blowing - Portata aria ventil. lato armadio, bocca libera Luftmenge Schrankseite, freiblasend - Caudal aire ventil. Lado armario	m3/h	575	575	575	575	575
Regulation Temperature limits - Limiti di regolazione Temperatura Temperatur Einstellbereich - limites de ajuste de Temperatura	°C	-5 / +55	-5 / +55	-5 / +55	-5 / +55	-5 / +55
Side ambient Temperature limits - Limiti di Temperatura lato ambiente Umgebungstemperatur - Limites Temperatura lado ambiente	°C	-5 / +55	-5 / +55	-5 / +55	-5 / +55	-5 / +55
Side cabinet protection degree - Protezione lato armadio Schutzgrad Schrankseite - Protección lado armario	IP/Type	55	55	55	54/12	54/12
Noise level - Rumorosità - Geräuschpegel - Nivel de ruido	dB(A)	76	76	76	76	76
Weight - Peso - Gewicht - Peso	kg	7,5	7,5	7,5	7,5	7,5
Installation - Installazione - Installation - Instalación		Interna / External	Internal	External	Internal / External	Internal / External
Mechanical Thermostat - Termostato Meccanico - Mechanischer Thermostat - Termostato mecánico		No	Yes	Yes	No	No

OPTIONAL

Special Colour - Colore Speciale OCAXNS03
Stainless Steel Housing - Carpenteria Inox AISI304 OCAXI02

Unità 230 V UL può funzionare anche a 50 Hz
230V UL unit can work with frequency 50 Hz



HE

**XVA
XVA50**

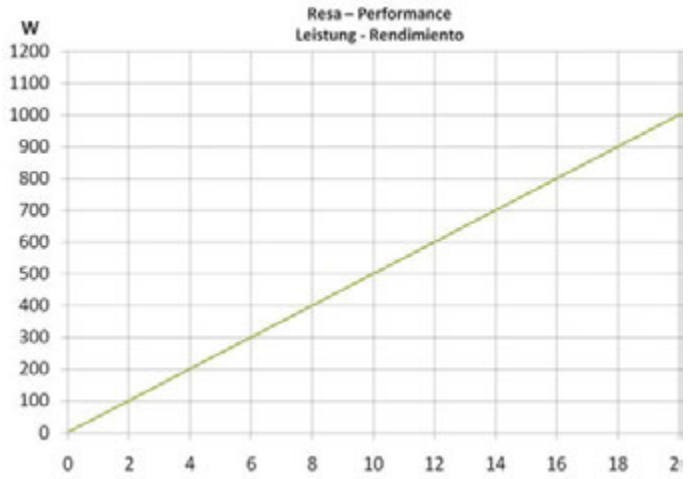
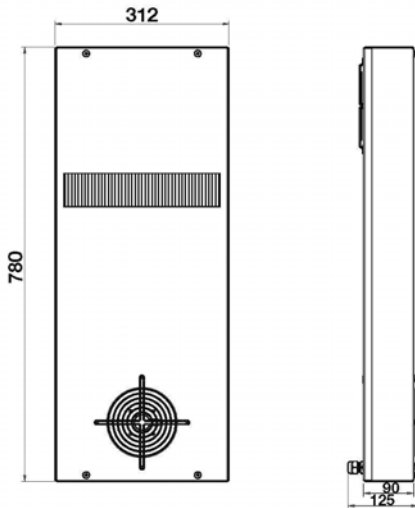

EXTERNAL INSTALLATION

INTERNAL INSTALLATION

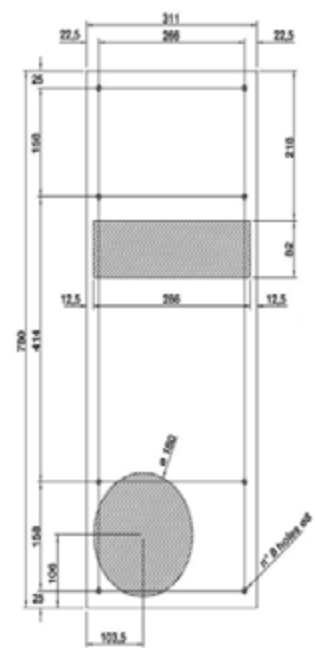
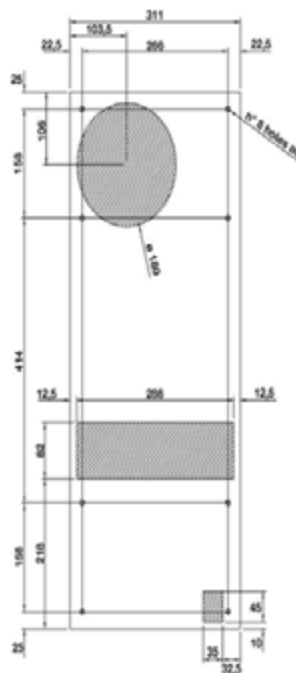

CODE - CODICE - MODEL - CODIGO	M.U.	XVA5000320	XVA50T0120	XVA50T0220	XVA50U1320	XVA50U1303
Power supply - Alimentazione - Spannungsversorgung - Tensión	V - ph - Hz	230-1-50/60	230-1-50/60	230-1-50/60	230-1-60	115-1-60
Specific heat transmission - Resa specifica Spezifische Leistung - Rendimiento específico	W/K	50	50	50	50	50
Height / Wicht / Depth - Altezza / Larghezza / Profondità Höhe / Breite / Tiefe - Altura / Ancho / Profundidad	mm	780x312x90	780x312x90	780x312x90	780x312x90	780x312x90
Absorbed current - Corrente assorbita - Stromaufnahme - Corriente absorbida	A	0,72	0,72	0,72	0,8	1,4
Pre-Fuse T - Fusibile T - Absicherung T - Elemento previo de fusibile T	A	2	2	2	2	4
Power consumption - Potenza assorbita - Leistungaufnahme - Potencia absorbida	W	160	160	160	150	180
Side cabinet fan flow, free blowing - Portata aria ventil. lato armadio, bocca libera Luftmenge Schrankseite, freiblasend - Caudal aire ventil. Lado armario	m3/h	575	575	575	575	575
Regulation Temperature limits - Limiti di regolazione Temperatura Temperatur Einstellbereich - limites de ajuste de Temperatura	°C	-5 / +55	-5 / +55	-5 / +55	-5 / +55	-5 / +55
Side ambient Temperature limits - Limiti di Temperatura lato ambiente Umgebungstemperatur - Limites Temperatura lado ambiente	°C	-5 / +55	-5 / +55	-5 / +55	-5 / +55	-5 / +55
Side cabinet protection degree - Protezione lato armadio Schutzgrad Schrankseite - Protección lado armario	IP/Type	55	55	55	54/12	54/12
Noise level - Rumorosità - Geräuschpegel - Nivel de ruido	dB(A)	76	76	76	76	76
Weight - Peso - Gewicht - Peso	kg	9,5	9,5	9,5	9,5	9,5
Installation - Installazione - Installation - Instalación		Internal / External	Internal	External	Internal/External	Internal/External
Mechanical Thermostat - Termostato Meccanico - Mechanischer Thermostat - Termostato mecánico		No	Yes	Yes	No	No

OPTIONAL

Special Colour - Colore Speciale OCAXNS03
Stainless Steel Housing - Carpentaria Inox AISI304 OCAXI02

Unità 230 V UL può funzionare anche a 50 Hz
230V UL unit can work with frequency 50 Hz

3046 Home Road. Powell, OH 43065
www.GenesisAutomationOnline.com

P: (740) 917-5781 F: (740) 917-5791
Sales@GenesisAutomationOnline.com



Indoor Heat Exchanger

HE

**XVA
XVA80**

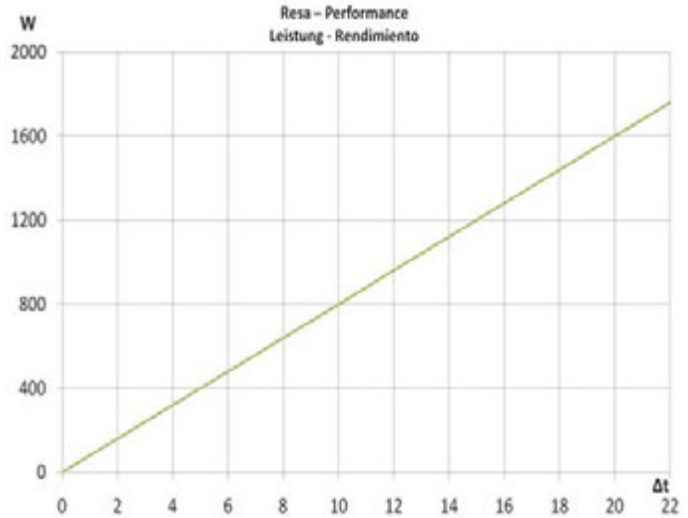
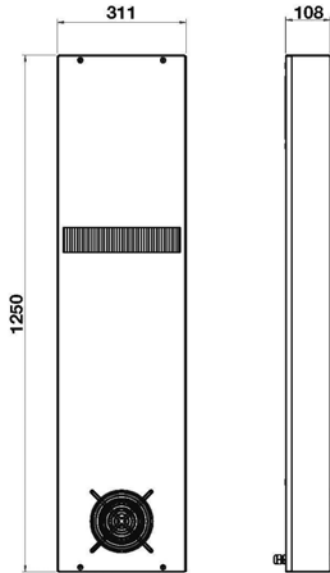

EXTERNAL INSTALLATION

INTERNAL INSTALLATION

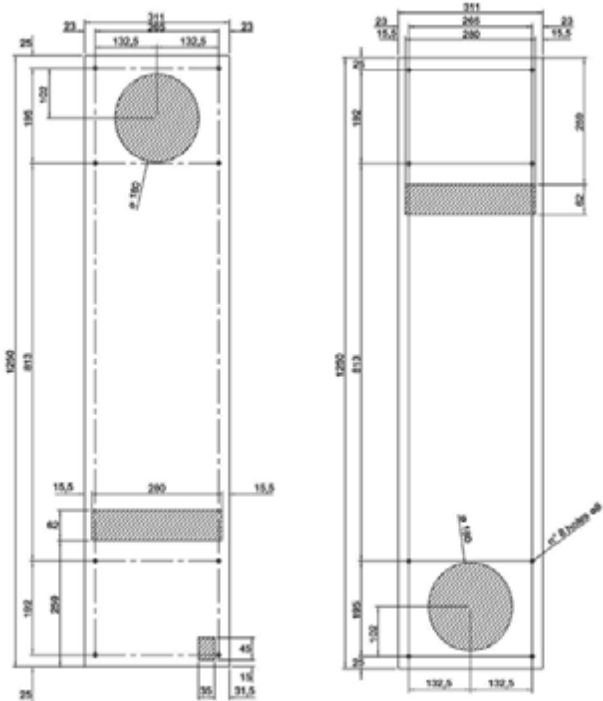

CODE - CODICE - MODEL - CODIGO	M.U.	XVA8000320	XVA80U1320	XVA80U1303
Power supply - Alimentazione - Spannungsversorgung - Tensión	V - ph - Hz	230-1-50/60	230-1-60	115-1-60
Specific heat transmission - Resa specifica Spezifische Leistung - Rendimiento específico	W/K	80	80	80
Height / Wicht / Depth - Altezza / Larghezza / Profondità Höhe / Breite / Tiefe - Altura / Ancho / Profundidad	mm	1250x311x108	1250x311x108	1250x311x108
Absorbed current - Corrente assorbita Stromaufnahme - Corriente absorbida	A	1	1,3	2,3
Pre-Fuse T - Fusibile T - Absicherung T Elemento previo de fusibile T	A	2	4	4
Power consumption - Potenza assorbita Leistungsaufnahme - Potencia absorbida	W	170	180	230
Side cabinet fan flow, free blowing - Portata aria ventil. lato armadio, bocca libera Luftmenge Schrankseite, freiblasend - Caudal aire ventil. Lado armario	m3/h	860	860	860
Regulation Temperature limits - Limiti di regolazione Temperatura Temperatur Einstellbereich - limites de ajuste de Temperatura	°C	-5 / +55	-5 / +55	-5 / +55
Side ambient Temperature limits - Limiti di Temperatura lato ambiente Umgebungstemperatur - Limites Temperatura lado ambiente	°C	-5 / +55	-5 / +55	-5 / +55
Side cabinet protection degree - Protezione lato armadio Schutzgrad Schrankseite - Protección lado armario	IP/Type	55	54/12	54/12
Noise level - Rumorosità - Geräuschpegel - Nivel de ruido	dB(A)	76	76	76
Weight - Peso - Gewicht - Peso	kg	20	20	20
Installation - Installazione - Installation - Instalación		Internal / External	Internal / External	Internal / External
Mechanical Thermostat - Termostato Meccanico - Mechanischer Thermostat - Termostato mecánico		No	No	No

OPTIONAL

Special Colour - Colore Speciale OCAXNS01
Stainless Steel Housing - Carpentaria Inox AISI304 OCAXI03

Unità 230 V UL può funzionare anche a 50 Hz
230V UL unit can work with frequency 50 Hz

3046 Home Road. Powell, OH 43065
www.GenesisAutomationOnline.com

P: (740) 917-5781 F: (740) 917-5791
Sales@GenesisAutomationOnline.com



HE

**XVA
XVA90**

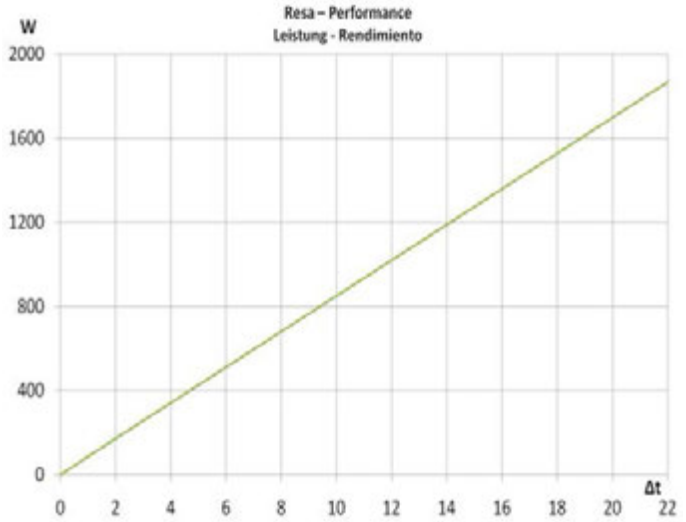
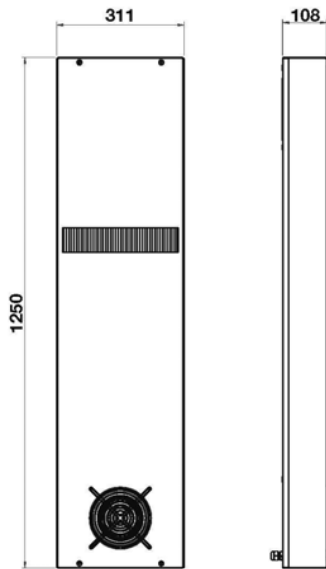

EXTERNAL INSTALLATION

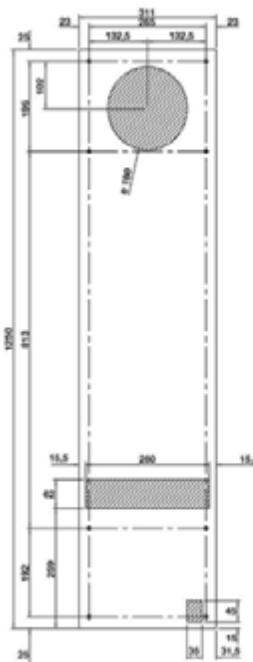

INTERNAL INSTALLATION

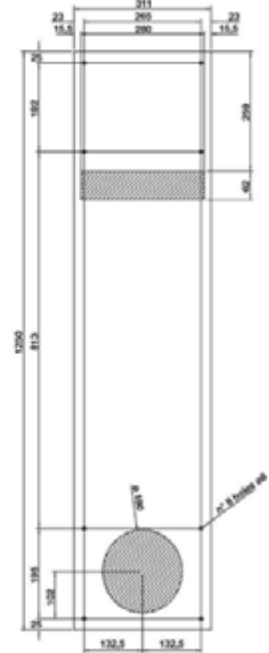

CODE - CODICE - MODEL - CODIGO	M.U.	XVA90T0120	XVA90T0220
Power supply - Alimentazione - Spannungsversorgung - Tensión	V - ph - Hz	230-1-50/60	230-1-50/60
Specific heat transmission - Resa specifica Spezifische Leistung - Rendimiento específico	W/K	85	85
Height / Widht / Depth - Altezza / Larghezza / Profondità Höhe / Breite / Tiefe - Altura / Ancho / Profundidad	mm	1250x311x108	1250x311x108
Absorbed current - Corrente assorbita - Stromaufnahme - Corriente absorbida	A	1	1
Pre-Fuse T - Fusibile T - Absicherung T - Elemento previo de fusibile T	A	1,5	1,5
Power consumption - Potenza assorbita - Leistungaufnahme - Potencia absorbida	W	340	340
Side cabinet fan flow, free blowing - Portata aria ventil. lato armadio, bocca libera Luftmenge Schrankseite, freiblasend - Caudal aire ventil. Lado armario	m3/h	1050	1050
Regulation Temperature limits - Limiti di regolazione Temperatura Temperatur Einstellbereich - limites de ajuste de Temperatura	°C	-5 / +55	-5 / +55
Side ambient Temperature limits - Limiti di Temperatura lato ambiente Umgebungstemperatur - Limites Temperatura lado ambiente	°C	-5 / +55	-5 / +55
Side cabinet protection degree - Protezione lato armadio Schutzgrad Schrankseite - Protección lado armario	IP	55	55
Noise level - Rumorosità - Geräuschpegel - Nivel de ruido	dB(A)	75	75
Weight - Peso - Gewicht - Peso	kg	20	20
Installation - Installazione - Installation - Instalación		Internal	External
Mechanical Thermostat - Termostato Meccanico - Mechanischer Thermostat - Termostato mecánico		Yes	Yes

OPTIONAL

Special Colour - Colore Speciale OCAXNS01
Stainless Steel Housing - Carpentaria Inox AISI304 OCAXIO3